

who has solutions
for advanced
ceramics?

—
we do.



ashland.com / efficacy usability allure integrity profitability™

advanced ceramics

who gets fired up at the thought of solving a problem? we do.

Ashland products are used in many traditional and advanced ceramic applications. Depending on whether the shaping process is starting with wet (slurry/slip), dry (spray dried/granulated) or plastified ceramic base materials the functionalities range from improving dispersibility of inorganic materials in the solvent over foam control, binding (wet & dry green strength), film formation, extrudability, plastification, controlled drying and many more.

Independent of the end product Ashland's knowledge and products can help you to reduce waste and increase quality. The shaping processes in which Ashland products can make a significant difference are listed in this document together with product recommendations and typical properties and benefits.

During the drying process, these ingredients help to ensure uniform, controlled drying and prevent the formation of cracks and blisters that can affect the performance of the carrier, filter and other shapes. Although the needs are the same, different binders are used for the different manufacturing processes depending on raw materials, equipment used as well as end product requirements and process conditions. Ashland offers a variety of products that can help solve manufacturing needs.

who helps
shape the future?
—
we do.

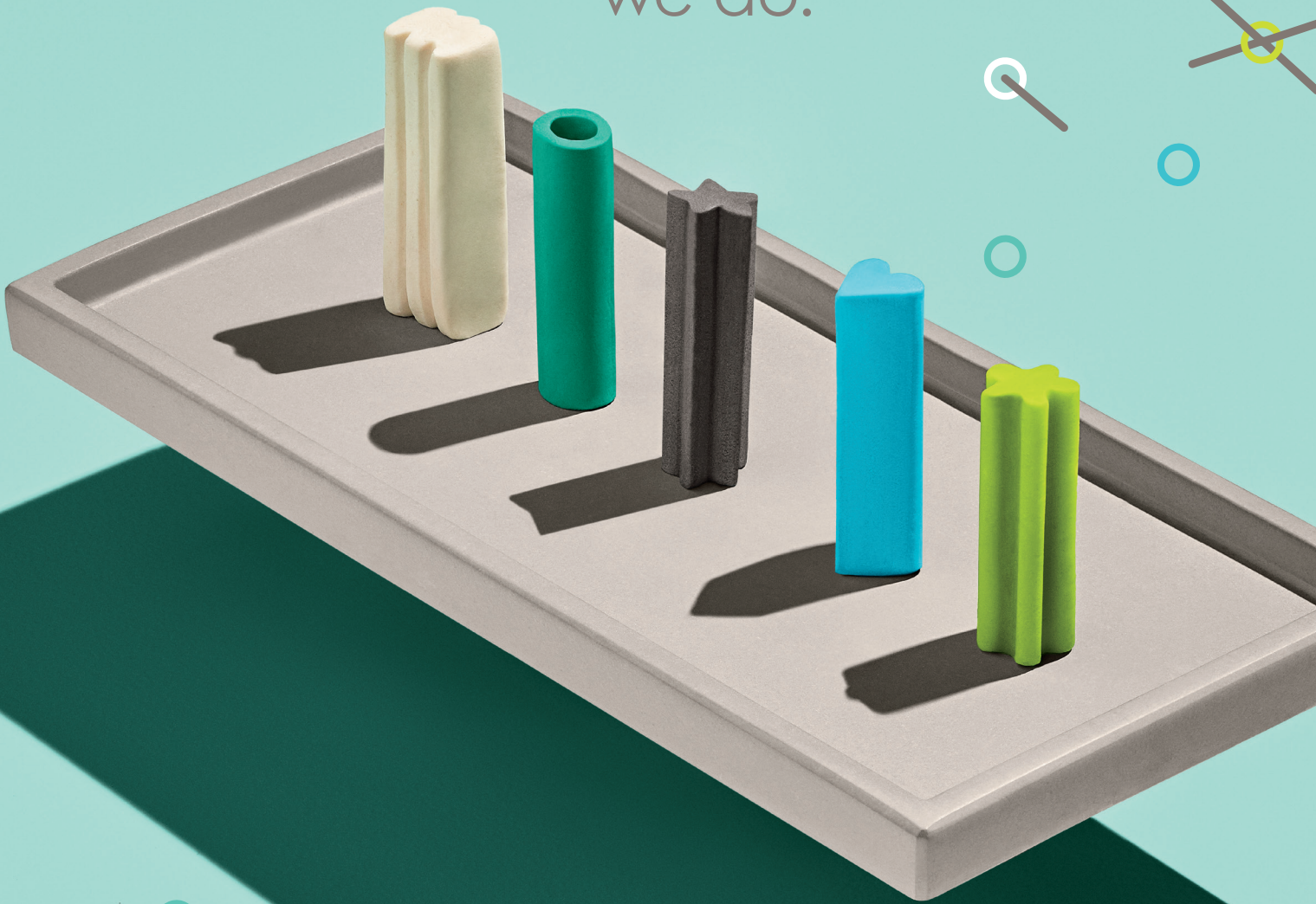

 ashland.com

/ efficacy usability allure integrity profitability™

 **Ashland™**
always solving

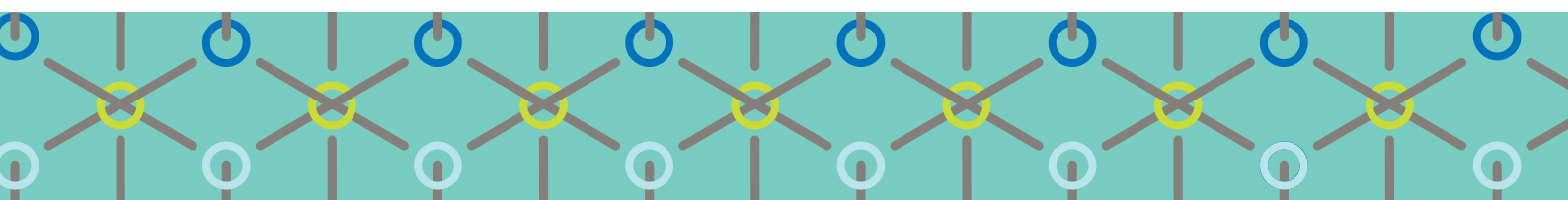

what are the most common shaping processes in which Ashland products are used?

- pelletization/granulation
(raw material handling, all sphere like particles)
- dry (die-/uniaxial-/isostatic-) pressing
(distance holders, insulators...)
- slip casting (hollow bodies...)
- tape casting (electronics, circuit boards...)
- injection molding (valves, gears...)
- plastification and extrusion (rods, tubes, catalyst substrates, honeycombs, particle filters...)

More about the individual shaping techniques, binders suggested and specific recommendations on the following pages.

process steps in advanced ceramic manufacturing

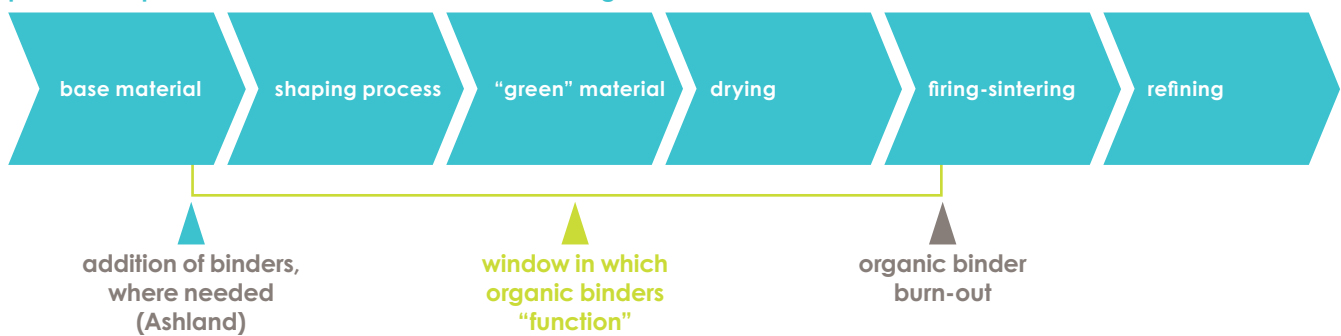

cellulosic binders & main properties

why are binders required and used in ceramic applications?

When ceramics are brought into specific shapes, often organic "binders" are required to support processing and provide additional benefits (see below).

Those binders are temporarily supporting the shaping and drying process and are typically almost 100% removed during the firing/sintering step.

Type and concentration of binder needed depends on the raw material choice and the state the material is shaped from (wet/dry powder, plastified mass, slurry/slip).

Even though the products are often called binders, the functionality is much broader and goes beyond just "binding".

Following properties, to name the main ones, are contributed by binders during the shaping as well as during and after the drying process:

- impact of binder on viscosity/rheology of the material to be shaped
- stabilization characteristics (e.g. suspension improvement in ceramic slips, reducing sedimentation without significant increase in viscosity)
- plastification and lubrication properties (e.g. increased extrudability and reduced wear and tear in extrusion processes)
- water retention capability
- green strength/shape retention before and after drying
- optimized water release during drying
- binding properties after drying
- burnout characteristics under normal (with oxygen) and inert (no oxygen present) conditions
- effect of impurities such as sodium (or other metals), which may have an impact on end product (e.g. impact on conductivity or "poisoning" of catalytic activity)

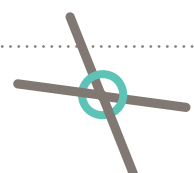

what are the most common Ashland binders for advanced ceramics?

Ashland offers a large variety of cellulose ethers. Some of those products develop their full potential when dissolved in water, some dissolve in water and polar solvents and others are only soluble and active in specific organic solvents.

culminal™ and **benecel™** methyl cellulose derivatives

Methyl cellulose derivatives are widely used in advanced ceramics as e.g. plastification/extrusion aids to improve green strength during extrusion. Depending on the chemistry of the binder (or combinations of binders) the rheological profile changes. The formulations can be optimized by picking the right binder or binder combination to:

- achieve the correct plasticity of the ceramic mass
- control the required water demand
- influence extrusion pressure and extrudability
- shift extrusion temperature window to higher values
- support the controlled drying process
- burn out almost residue-free during the firing process due to the use of high purity natural organic raw materials

aqualon™ and **blanose™** CMC (sodium carboxymethyl cellulose)

Low molecular weight CMC is widely used for pressing applications, where it is incorporated as a binder during the spray drying process of the ceramic slip or during granulation step. Other uses are in slip- or tape casting applications.

Application for higher molecular weight and often fine particle sized products would be pressing and ceramic extrusion. Due to our high purity CMC can even be used in sodium sensitive applications.

klucel™ HPC (hydroxypropyl cellulose)

HPC products are very special in their properties. Being soluble in both water and polar organic solvents they offer a broad choice of systems to be used in. This opens a lot of application fields from pressing over slip and tape casting. Due to its thermoplastic character, makes it an excellent chemistry to be used in injection molding processes. Some examples for injection molding applications are bio-ceramics & aerospace parts such as turbine blades. HPC also leads to very flexible films and reduces brittleness in the "green" state.

natrosol™ HEC (hydroxyethyl cellulose)

HEC products find use in various ceramic shaping processes. Low molecular weight products are being used in e.g. ceramic slips for pressing, slip- and tape casting. Higher molecular weight HEC is used in ceramic extrusion processes, where it supports extrusion at higher temperatures.

aqualon™ EC (ethyl cellulose)

EC products are utilized in ceramic applications, in which excellent film forming properties are required and organic solvents are used as a dissolution medium. In such applications Aqualon EC dissolves in the organic solvent and, after evaporation of the solvent, develops strong and water insoluble films leading to high cohesion in the dried state.

Each of those product groups consist of materials differing in:

- type of chemical substitution, solubility in different media
- level/degree/distribution of chemical substitution tailored towards end use
- molecular weight/viscosity
- particle size (from very fine powders to granular materials)

Ashland cellulose ethers are beneficial in various parts of the manufacturing process

during shaping

- ensuring plasticity of inorganic materials
- improving lubrication and slipping properties
- reducing equipment wear and tear
- improving firmness of the wet mass after extrusion (wet green strength)
- optimizing workability and rheology control

during drying

- ensuring uniform, controlled drying
- reducing binder migration to the surface during drying
- preventing formation of cracks and blisters
- increasing mechanical strength after drying (dry green strength)

during burnout

- almost complete binder burnout down to ppm levels
- leaving little or no residue
- resulting in minimal cracking (shrinkage)

Green strength is achieved by adsorption of the binding agents onto the ceramic particles.

Green strength is impacted by the following factors:

- concentration of the binding agent
- chemistry of binding agent used
- distribution of the binding agent
- wettability of the ceramic solids surface
- temperature
- adhesion of the binder after drying
- cohesion in the material
- compactability of the powder
- water-adsorbent properties of the binding agent

These factors are in turn depending on the type of forming process (e.g., extrusion, slip casting, injection molding, tape casting and spray drying and pelletization).

An appropriate binder is chosen for a system based on the following criteria:

- compatibility with other components
- type of process & end-product requirements
 - incorporation of binder
 - lubrication requirements
 - fiber content
 - temperature requirements
 - desired green strength
 - desired efficiency
 - drying time and water retention requirements
 - burn-out properties, residues, salts

thermal gelation:

Thermal gelation describes the phase transition towards a more hydrophobic nature by a rise in temperature.

Thermal gelation is particularly pronounced with methylcellulose, but also occurs with other methylcellulose derivatives. The gel strength (a measure of the ability of a dispersion to develop and retain a gel form based on its resistance to shear) and gel point (the point at which a liquid begins to exhibit increased viscosity) are dependent on the binder chemistry, molecular weight/viscosity as well as its concentration.

binder migration:

In ceramic processing, it is important that the binder remains homogeneously distributed within the body until the final sintering stage.

As the green body dries, the migration of water to the surface creates a capillary effect which can carry a binder with weak gelation to the ceramic surface.

This migration can cause voids or blistering of ceramic surfaces on burnout, substantially worsening the surface appearance of the extrudate.

Binder migration can be reduced by e.g. the following procedures

- use of high-viscosity cellulose ethers
- use of less liquid and reduction of interconnected water channels
- use of thermally gelling binders

Ashland cellulosic binders are very effective in preventing binder migration.

the shaping techniques

shaping through dry pressing

A powder (e.g. spray dried ceramic slurry including or excluding binder) is put into a mold and pressure is applied from one or more directions to compact the material into a specific (mostly simple) shape. Pressing can be uniaxial, where force is applied in one direction. This is used for shapes like discs or plates (e.g. tiles). It can also be isostatic, where the same pressure is applied from all directions. This is a more complex and more time-consuming process for e.g. insulators or wear parts.

Often the base materials for dry pressing are powders made by spray drying slurries of ceramic materials with binders or granulating powders.

In the slurry/slip for spray drying binders are used to agglomerate/bind the ceramic material upon solvent evaporation and the cellulose ethers provide:

- stabilization of the slurry (reduction of sedimentation)
- well-adjusted spraying rheology/ droplet size & shape control
- binding of individual particles into larger and stable agglomerates
- binding power/stability/strength once pressed and not yet fired

Alternatively, granulation is another technique of getting to a free-flowing and dust-free powder for dry pressing. A bit comparable to the snow-ball effect.

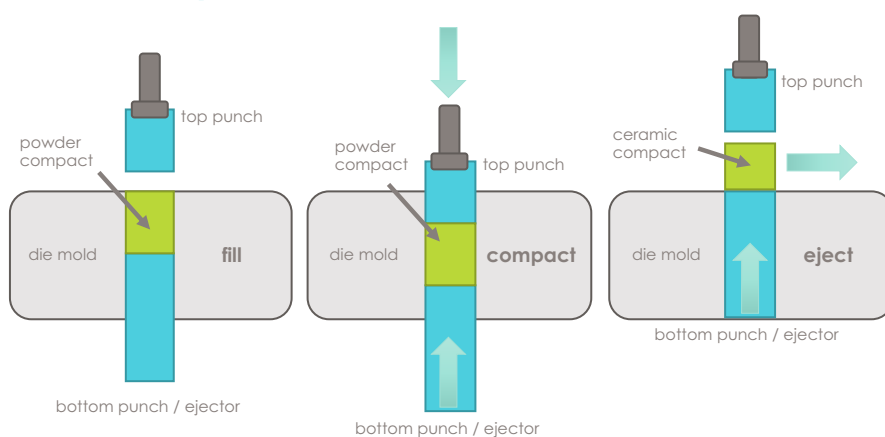

spray drying and granulation

During spray drying larger agglomerates are generated from smaller individual particles.

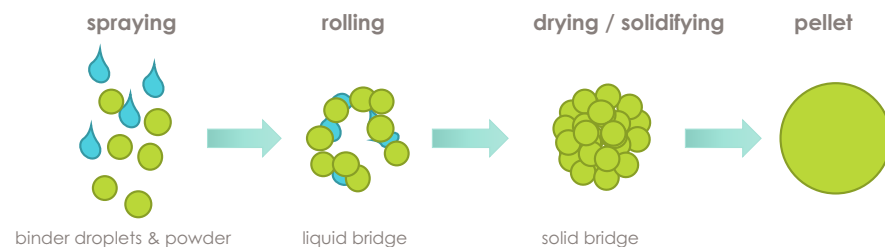

Also during granulation larger agglomerates are made from smaller individual particles.

recommendations for spray drying, granulation and dry pressing

- **aqualon™** and **blanose™** CMC
 - low molecular weight for spray drying and granulation (e.g. 7L)
 - medium- to high molecular weight when dry added as binder before pressing (e.g. 7M/7H/7H4/7H9)
- **culminal™** MHPC
 - retarded solubility (for lump-free incorporation, e.g. MHPC 400 R)
 - low molecular weight fine powder when dry added as binder before pressing (e.g. MHPC 500 PF)
- low molecular weight products needed to give stabilization and binding properties while avoiding too strong increase in viscosity
- typical addition level: 0.5-1 wt%

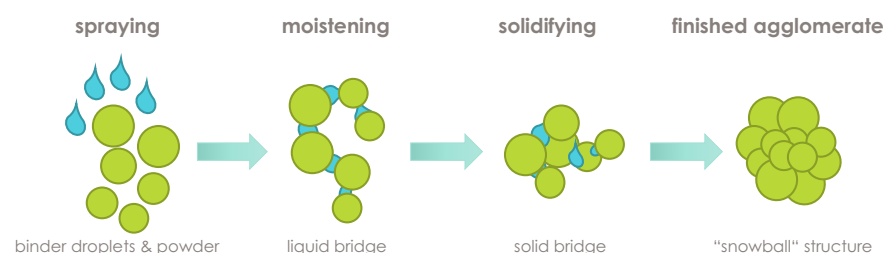

shaping through slip casting

Slip casting is more widely used for complex and often hollow shapes such as sanitaryware ceramics and tableware including porcelain articles.

A stabilized ceramic slip (slurry) is cast into typically a gypsum mold with a defined porosity, where capillary forces remove the water and lead to a layer of ceramic building up on the interface to the mold. The thickness of the walls is largely influenced by the porosity of the mold, slip viscosity and the time allowed to build the ceramic layer.

Remainder of the slip is poured out and then the mold is removed before drying and firing the ceramic body under controlled conditions.

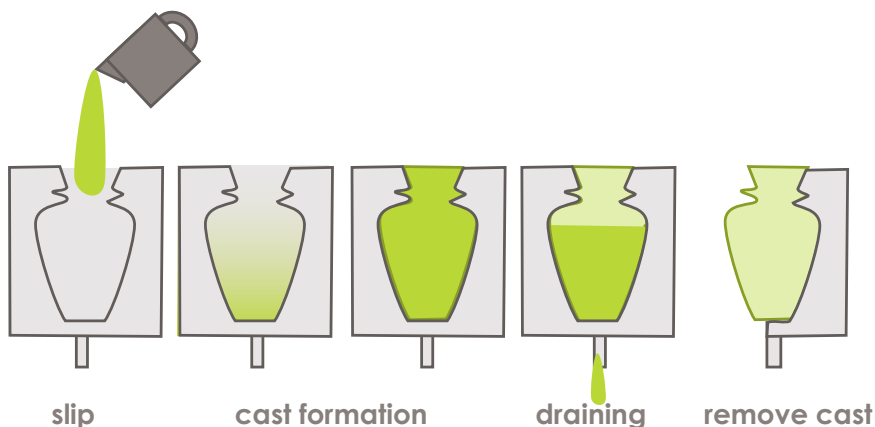

recommendations for slip casting

- Aqualon™ and Blanose™ CMC, low-medium molecular weight (e.g. 7M)
- Culminal™ MHPC, low-medium molecular weight (e.g. MHPC 400 R)
- Natrosol™ HEC, low-medium molecular weight (e.g. 250 GR or 250 MR)
- low molecular weight products needed to give stabilization and binding properties while avoiding too strong increase in viscosity
- typical addition level: 0.5 wt%

shaping through tape casting

For tape casting inorganic and organic components are mechanically dispersed in the liquid phase, which can be aqueous or solvent based.

Often the mix is ground/homogenized using ball mills and excessive air is removed (foam control agents and/or vacuum).

The slip is cast on a moving belt/foil and adjusted to correct thickness using a wiper or doctor blade. The cast layer is then dried, removed from the belt/foil, cut into right shape and fired.

Tape casting is commonly used to produce flat shapes such as ceramic capacitors and piezo-electronics.

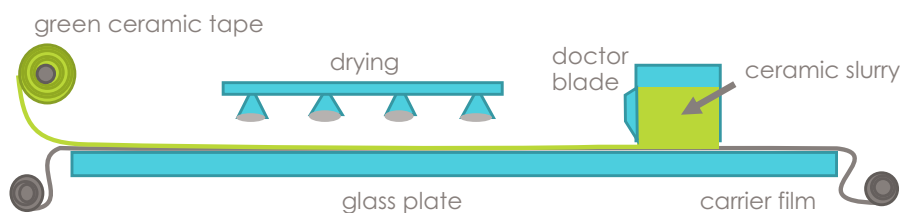

Ashland cellulose ethers:

- give green strength as well as elasticity to the thin and sensitive ceramic sheet/film
- improve drying behavior thus allow controlled drying of the ceramic product

recommendations for tape casting

- Natrosol™ HEC 250 L for aqueous systems
- Culminal™ MHPC 400 R for aqueous systems
- Klucel™ for solvent based systems (polar solvents, check solubility in solvent)
- Aqualon™ EC for solvent based systems (check solubility in solvent)
- low molecular weight products needed to give stabilization and binding properties while avoiding too strong increase in viscosity
- typical addition level: 5-10 wt%

shaping through injection molding

Ceramic powder is mixed with binder at 120-170°C and then is cooled down and granulated.

The granulated product is fed into the injection molding device where the mass is heated up in the injection cylinder and subsequently “sprayed” into the mold.

Injection molding is frequently used for manufacturing complex shapes such as bio-ceramics (e.g., joint replacements) and turbine components just to name a few.

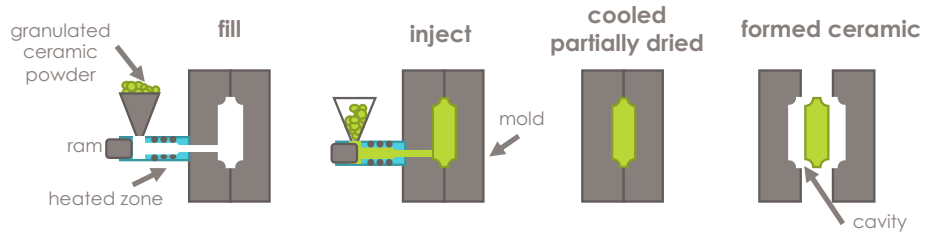

Cellulose ethers used for injection molding must be able to allow preparation of a thermoplastic mass which can be injected in the subsequent molding process.

recommendations for injection molding

- Klucel™ HPC
- Culminal™ MHPC 20000 S
- typical addition level: 5-20 wt%

recommended products by forming method

method	MC derivatives	HEC	HPC	CMC	EC	detail
pelletization/ granulation	Culminal™ MHPC400R MHPC500PF			Blanose™/ Aqualon™ CMC 7L		<ul style="list-style-type: none"> ○ dry blended or sprayed as solution ○ low molecular weight for high %age solution ○ fine grind preferable for dry blending ○ retarded solubility for lump-free dissolution
dry pressing/ die pressing (uniaxial/ isostatic)	Culminal™ MHPC400R MHPC500PF			Blanose™/ Aqualon™ CMC 7HX CMC 7HXF		<ul style="list-style-type: none"> ○ fine grind preferable for dry blending ○ CMC F-grades for lower salt content
slip casting	Culminal™ MHPC400R	Natrosol™ HEC 250 GR HEC 250 MR		Blanose™/ Aqualon™ CMC 7L CMC 7M		<ul style="list-style-type: none"> ○ low molecular weight for low impact on slip viscosity
tape casting	Culminal™ MHPC400R	Natrosol™ HEC 250 L HEC 250 LR	Klucel™ HPC E		Aqualon™ EC N-7 EC N-10	<ul style="list-style-type: none"> ○ binder chemistry depending on solubility in solvent (water?/polar organic?/non-polar organic?)
injection molding			Klucel™ HPC E			<ul style="list-style-type: none"> ○ thermo-processable polymer needed ○ HPC most suitable ○ start with low molecular weights
plastification and extrusion	Culminal™/ Benecel™ various grades	Natrosol™ HEC 210 HHX HEC 250 HHX		Blanose™/ Aqualon™ mid- to high viscosity CMC 7M CMC 7H9		<ul style="list-style-type: none"> ○ broader binder choice depending on performance needs ○ mainly MC and MC-derivatives ○ medium- to high-molecular weight

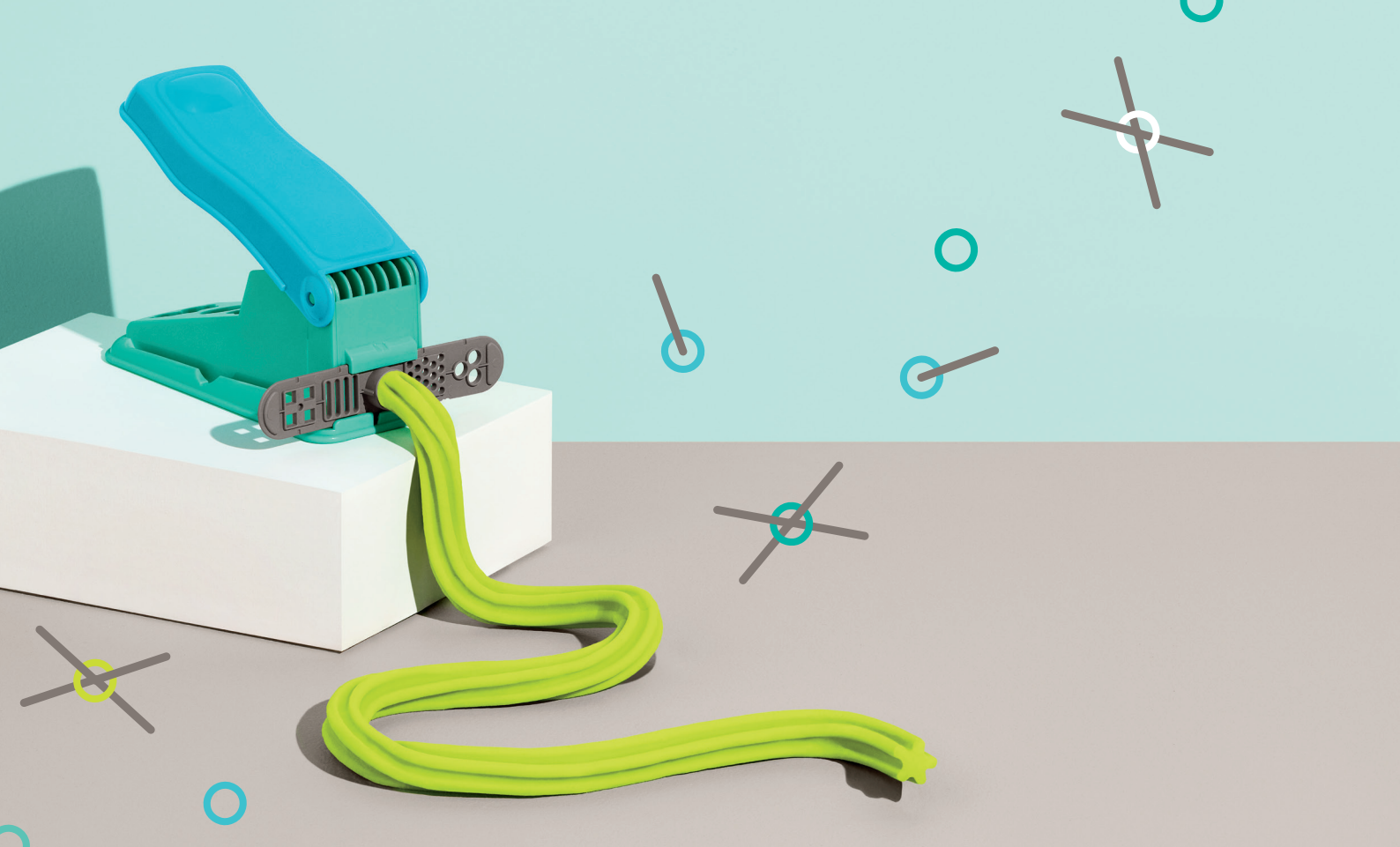

shaping through extrusion

Extrusion is one of the key ceramic shaping processes for e.g. emission control ceramics as well as carriers for catalysts. Shapes like rods, tubes or honeycombs are the main ones manufactured in this (typically continuous) process.

For the extrusion the ceramic material, pre-blended with a binder and other auxiliary products, is wetted with water and/or plastified into a high viscosity and extrudable mass. The mass is pressed through a die using either a ram or a screw. Due to this high pressure application and friction heat is developed in the process, which is an important parameter to be kept in mind for selecting the correct binder.

The rheology and consistency of the mass and the process conditions must be optimized in a way that the final extrudates keep the shape during the whole process from leaving the extruder to drying and firing.

One of the largest applications is monolithic catalytic carriers, which need to have a very large surface area to provide more surface for catalytic activity thus more efficient exhaust air purification. Those modern honeycomb substrates can have up to 1000 channels/inch² and wall thicknesses down to 2 mil. Also diesel and gasoline particulate filters (DPF/GPF) are very important extruded products.

The extrusion process is used for both traditional (split tiles, roof profiles, bricks) and advanced ceramics, where adjusted porosity plays a major role..

examples for extrusion of advanced ceramics:

- honeycomb substrates used for catalytic converters for emission control
- diesel and gasoline particle filters for mobile and stationary use
- carriers for catalysts for industrial use
- bed topping media, support media
- activated carbon shapes (honeycombs, pellets, sheets) for fuel/solvent absorption/recovery
- filters for molten metal
- ceramic filters for industrial use (nano-, ultra- and micro-filtration)
- furnace tubes

cellulose ethers provide:

- good plastification and extrudability
- lubrication to ease the extrusion and reduce wear and tear of the equipment (e.g. screws and dies)
- controlled rheology optimized towards process conditions
- high wet green strength and dry green strength, shape retention
- high water retention for controlled drying
- excellent burnout properties

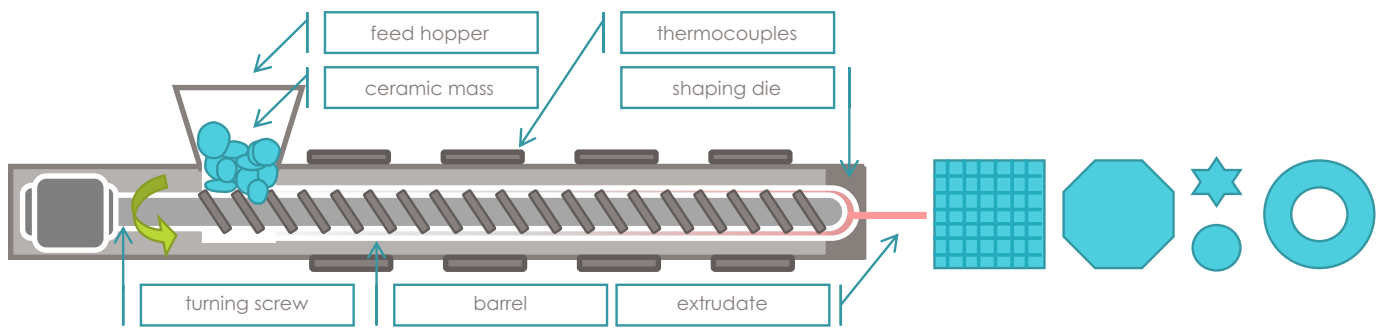

examples of extruded ceramics

Ceramic substrates for emission control

are extruded ceramic parts, which provide a very high surface area. This allows application of a catalyst (through coating it with typically a rough layer of PGM/platinum group material containing "washcoat").

Cellulosic binders need to be optimized towards very low sodium levels and low levels of low- or unreacted cellulose, which can build up in front of screens or the extruder die and block the die leading to a time consuming and undesired cleaning process (especially when a high density of cells and very thin walls are needed).

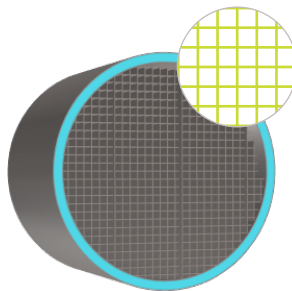

Ceramic substrates/supports for industrial use come in many shapes and forms. They either include or are post-treated with a catalyst and specifically designed for controlling chemical reactions.

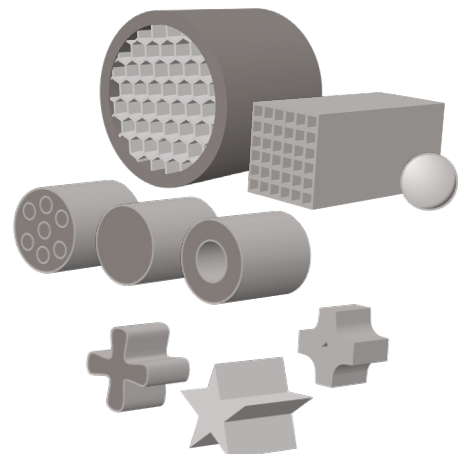

Ceramic filters

are also extruded ceramics. Typically the walls are thicker than in substrates and need a well-defined porosity. Alternate channels are blocked on opposing sides, which will later "force the exhaust stream" through the (more or less porous) walls of the filter and take out solid matter (almost 100% removal of solids).

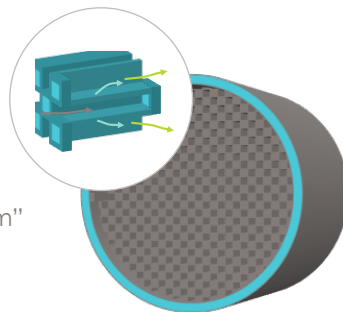

Ceramic filters/filter membranes

are single or multiple-channel tubes with a well-defined porosity. They are used in many industrial processes from very fine filtration to filtration of molten metals.

recommendations for extrusion

- Culminal™ & Benecel™ methylcellulose derivatives
- Natrosol™ HEC
- no specific grades are listed as correct choice of binder needs a clear understanding of raw material, process as well as end product requirements (please contact your Ashland representative for a technical discussion and product advice)
- typical use level: 1-3 wt%

regional sales offices

North America

The Woodlands, TX USA
Tel: +1 281 465 6800

Latin America

São Paulo, Brazil
Tel: +55 11 3649 0455

Mexico City, Mexico
Tel: +52 55 5276 6110

Buenos Aires, Argentina
Tel: +54 11 4314 8971

Asia Pacific

Singapore
Tel: +65 6775 5366

Mumbai, India
Tel: +91 22 61484646

Shanghai, P.R. China
Tel: +86 21 2402 4888

Europe

Schaffhausen, Switzerland
Tel: +41 52 560 5500

Middle East & Africa

Dubai, U.A.E.
Tel: +971 4 393 2431

ashland.com/contact

® Registered trademark, Ashland or its subsidiaries, registered in various countries

™ Trademark, Ashland or its subsidiaries, registered in various countries

* trademark owned by a third party

© 2020, Ashland / IND20-157

 / efficacy usability allure integrity profitability™

 **Ashland**[™]
always solving

The information contained in this brochure and the various products described are intended for use only by persons having technical skill and at their own discretion and risk after they have performed necessary technical investigations, tests and evaluations of the products and their uses. Certain end uses of these products may be regulated pursuant to rules or regulations governing medical devices, drug uses, or pesticidal or antimicrobial uses. It is the end user's responsibility to determine the applicability of such regulations to its products. All statements, information, and data presented herein are believed to be accurate and reliable, but are not to be taken as a guarantee of fitness for a particular purpose, or representation, express or implied, for which seller assumes legal responsibility. No freedom to use any patent owned by Ashland, its subsidiaries, or its suppliers is to be inferred.